

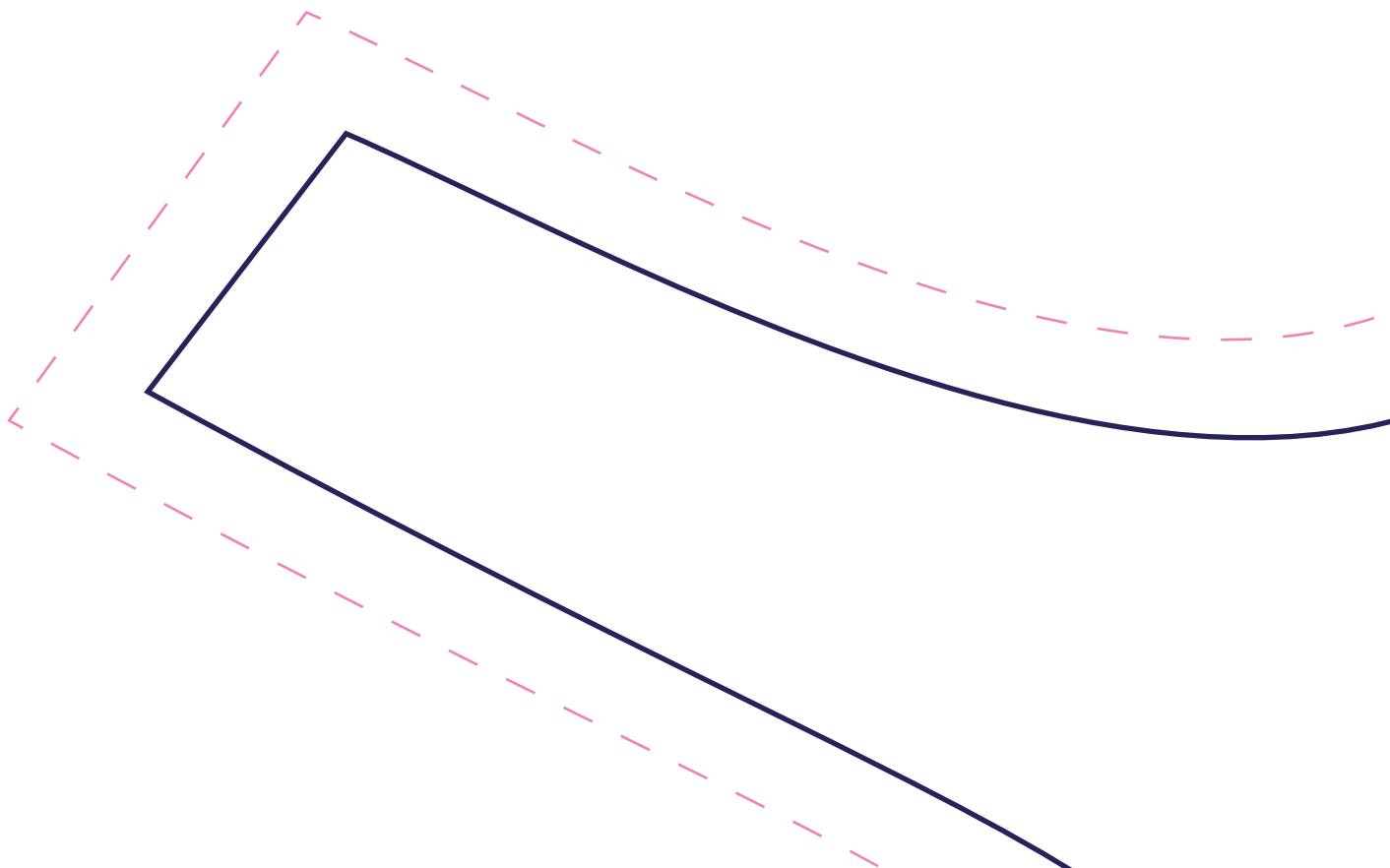

Flip Tunic by Su  
Free for personal use. M  
[www.superminx.com](http://www.superminx.com)

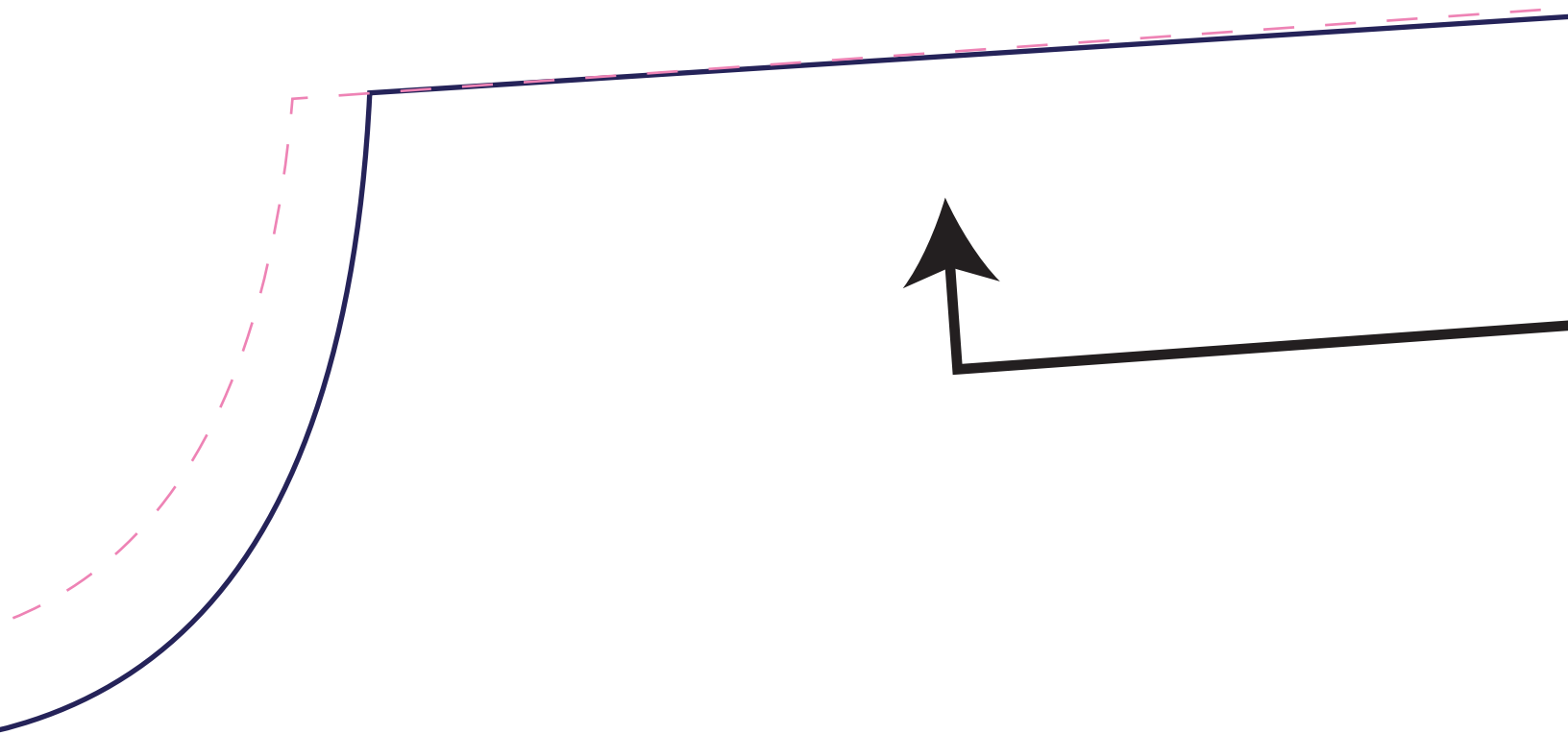

iperMinx - © 2013 Ar  
No overlap included on page



# ndi Morton tiles

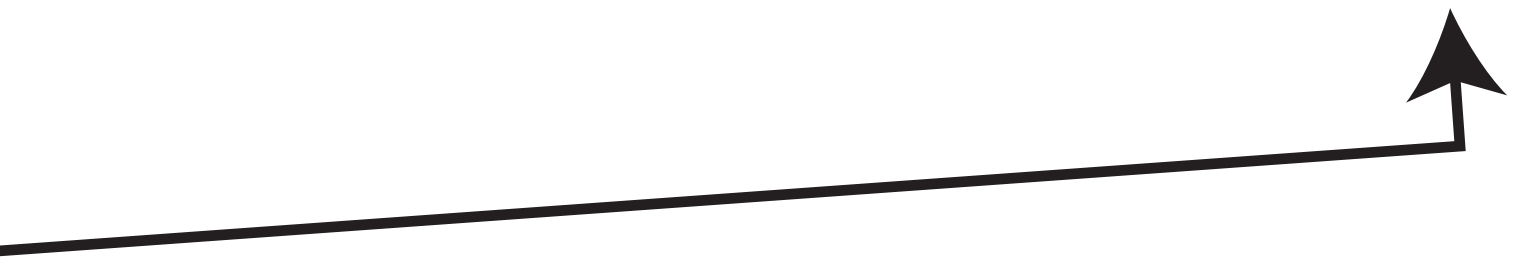

Place on Fold

Flip Tunic  
[front]

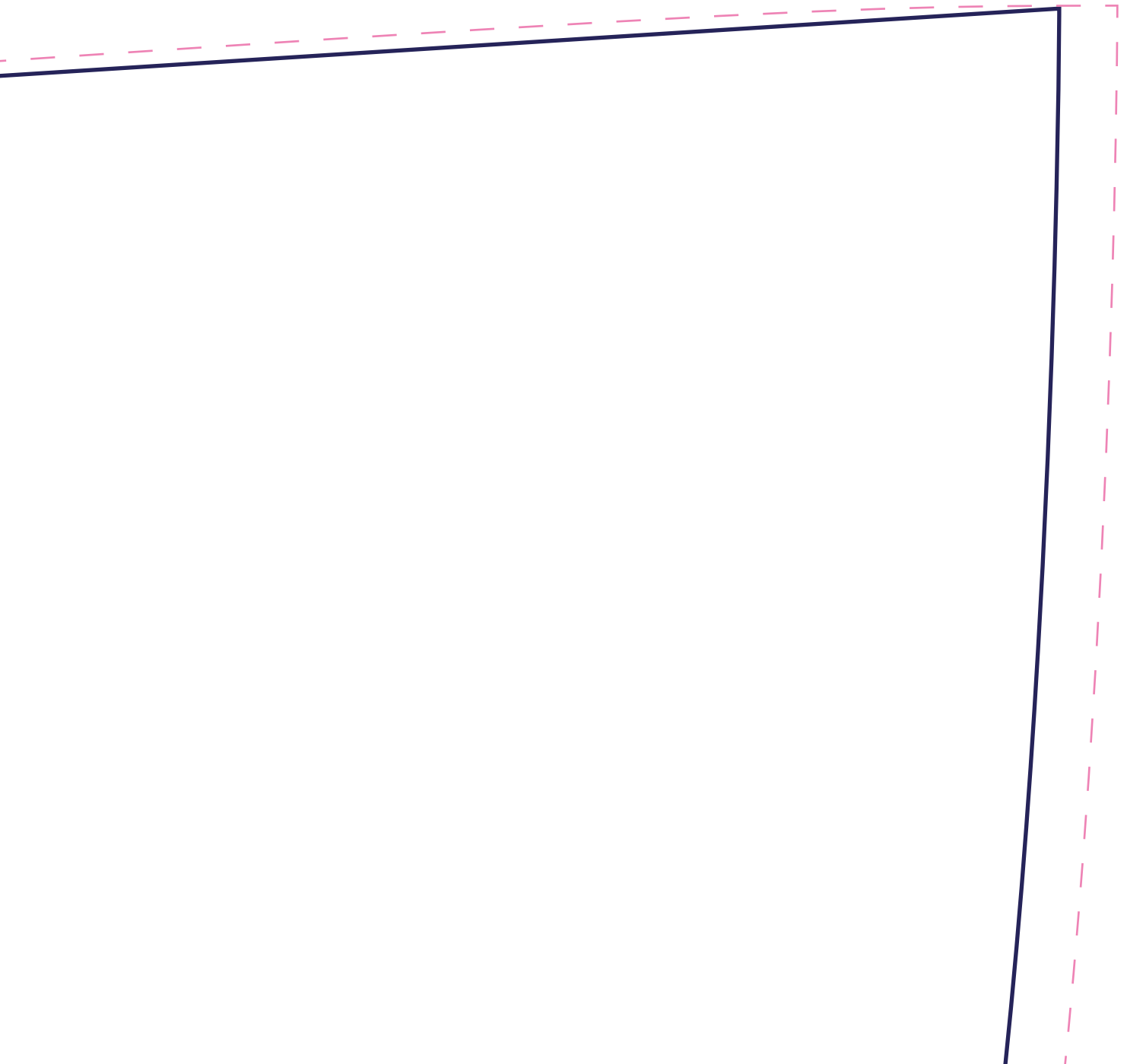



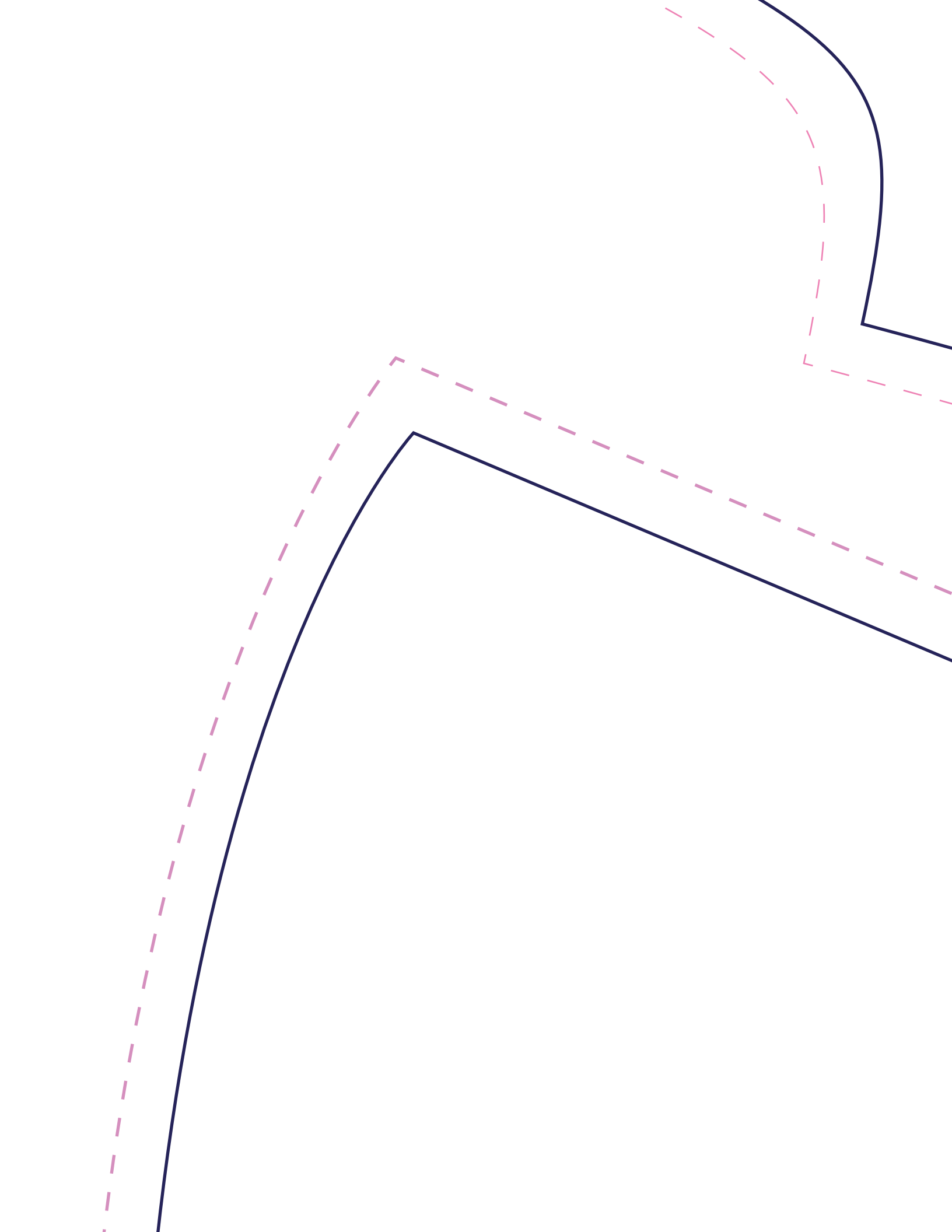

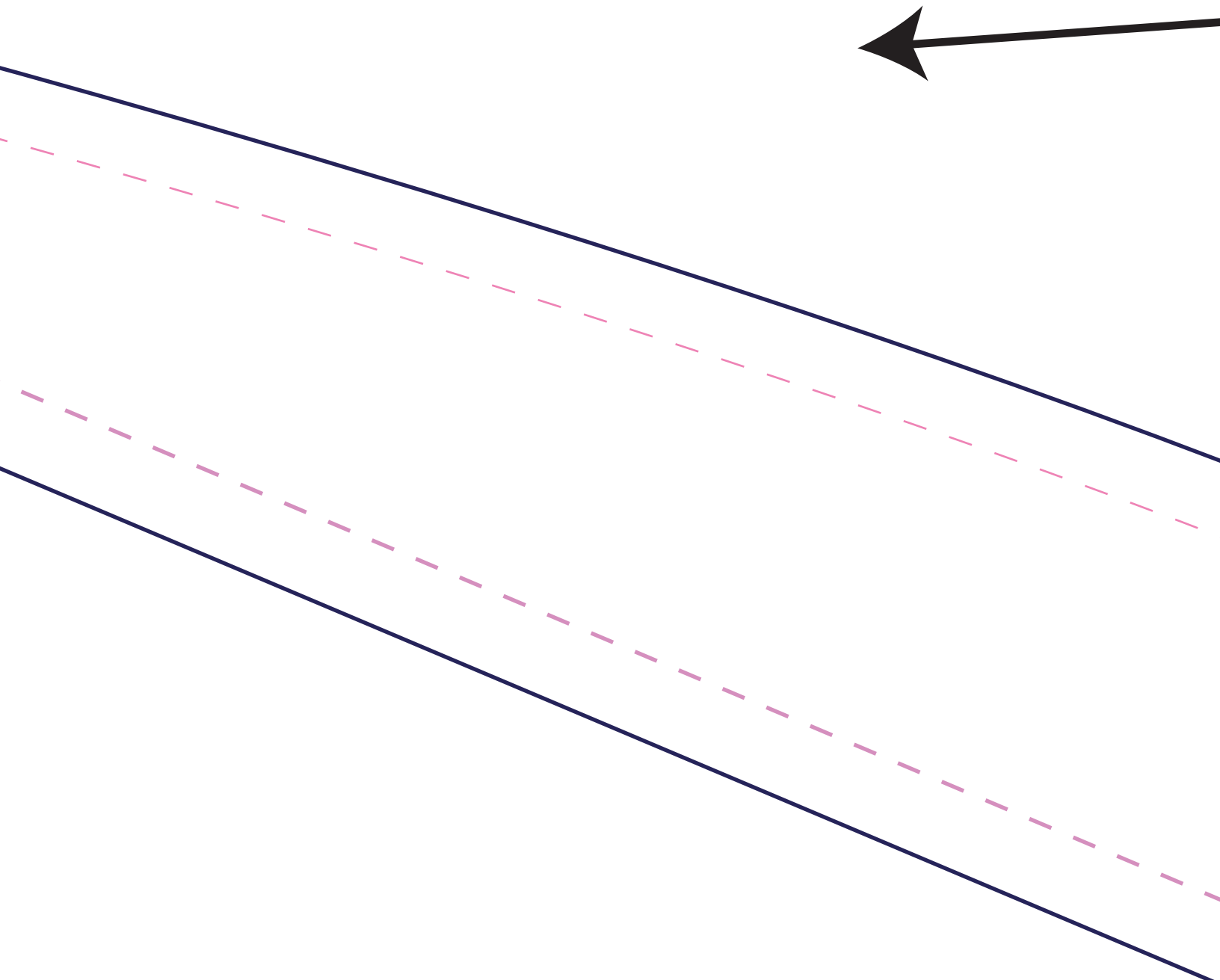

Flip Tunic

cut 1 on fold

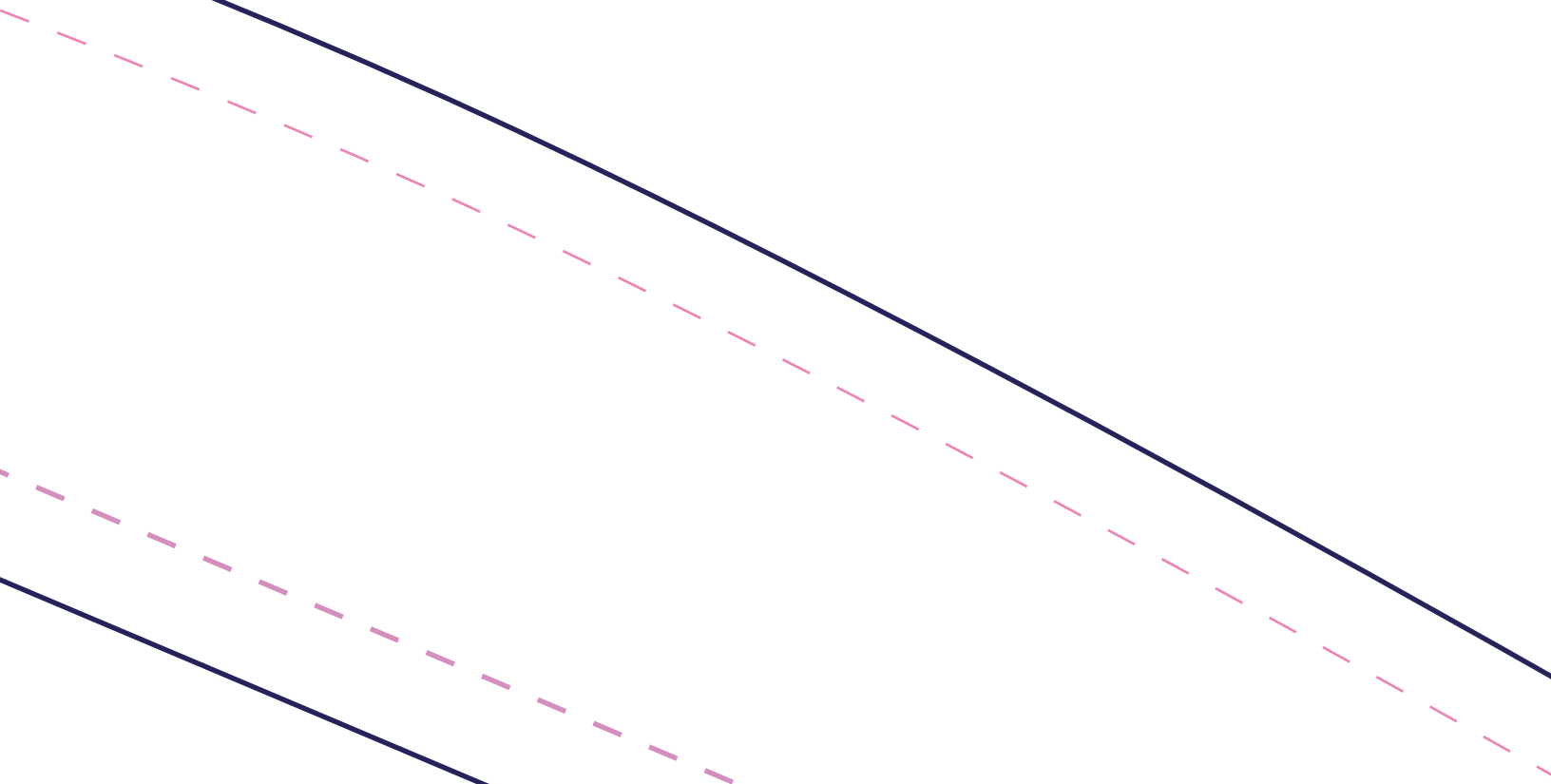
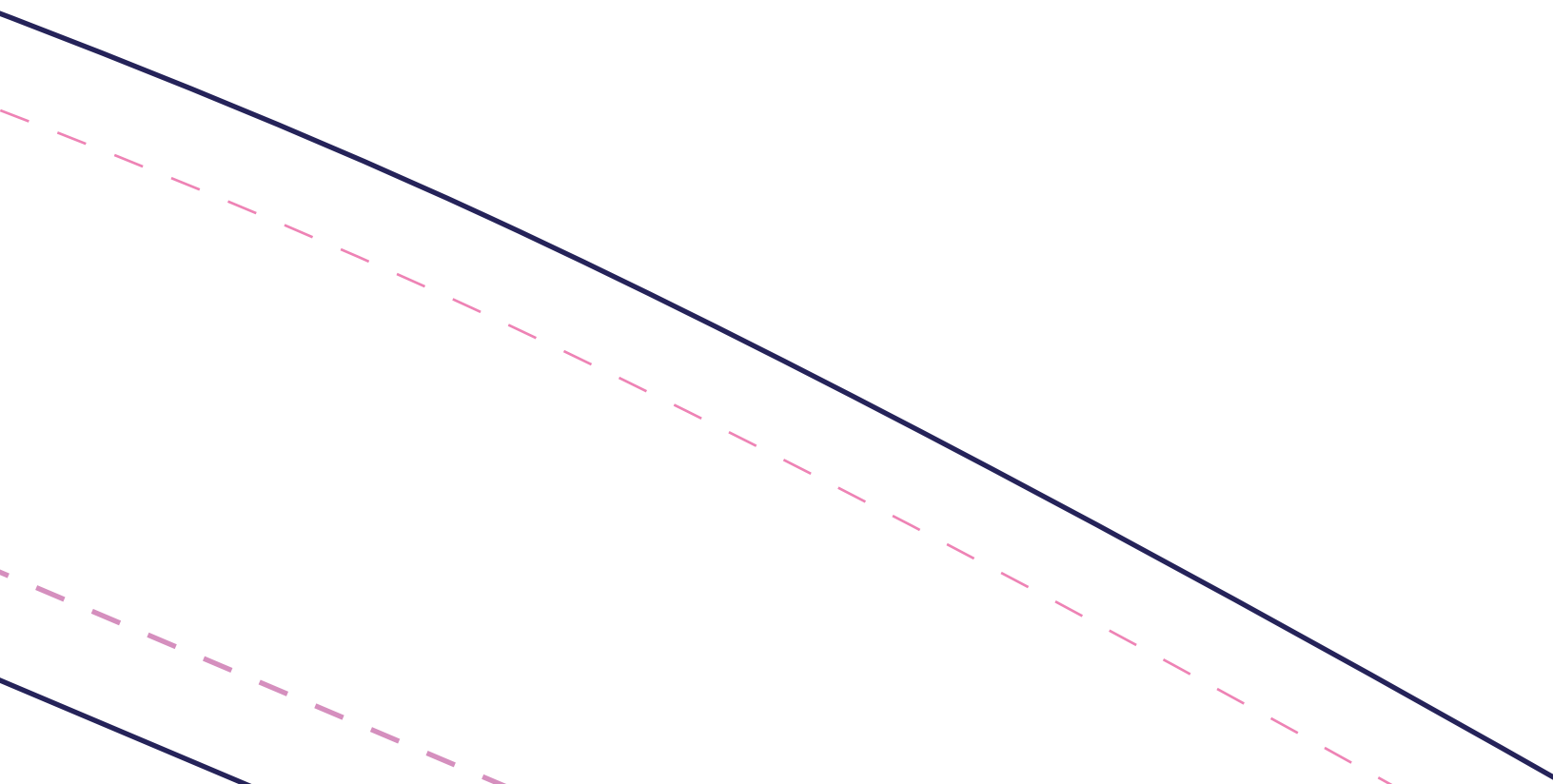



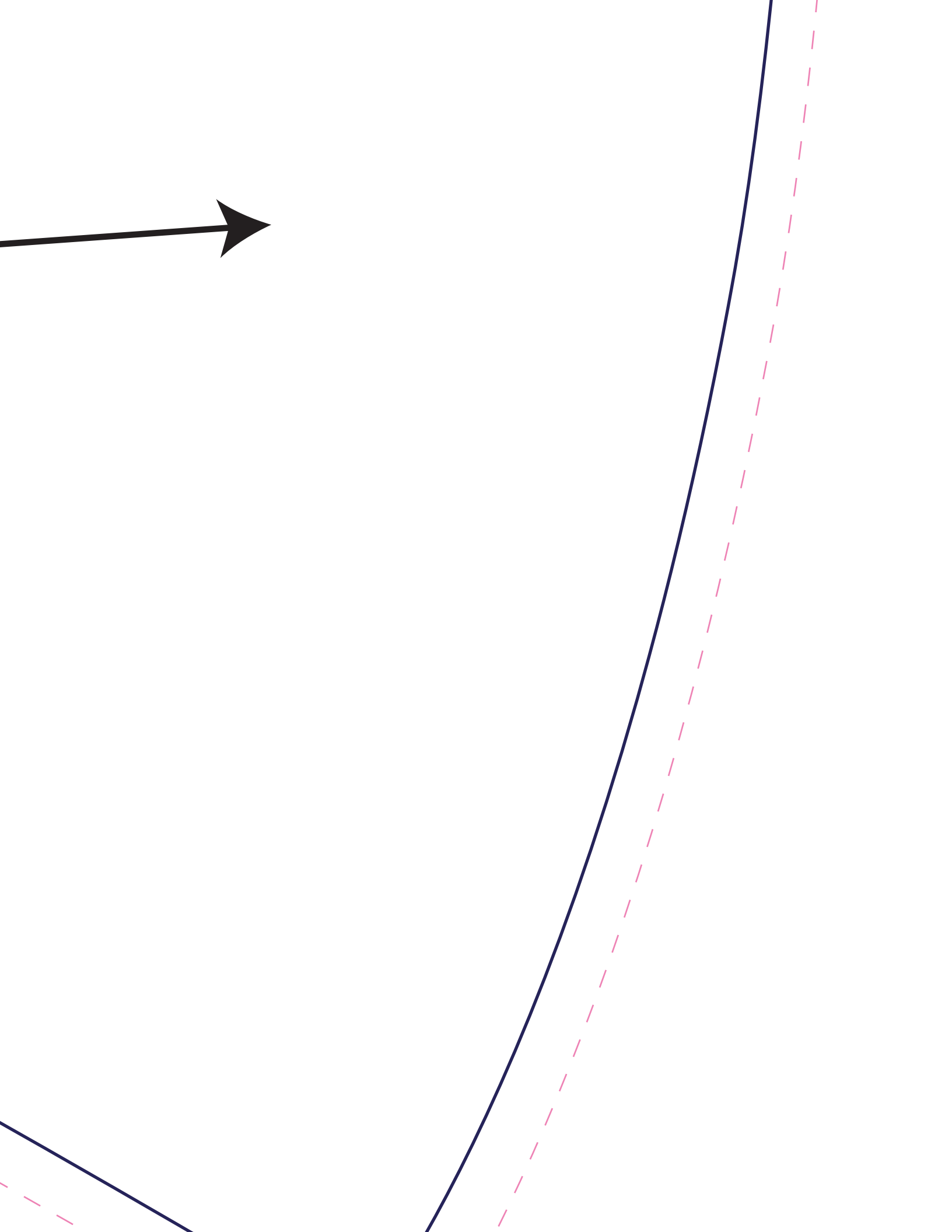



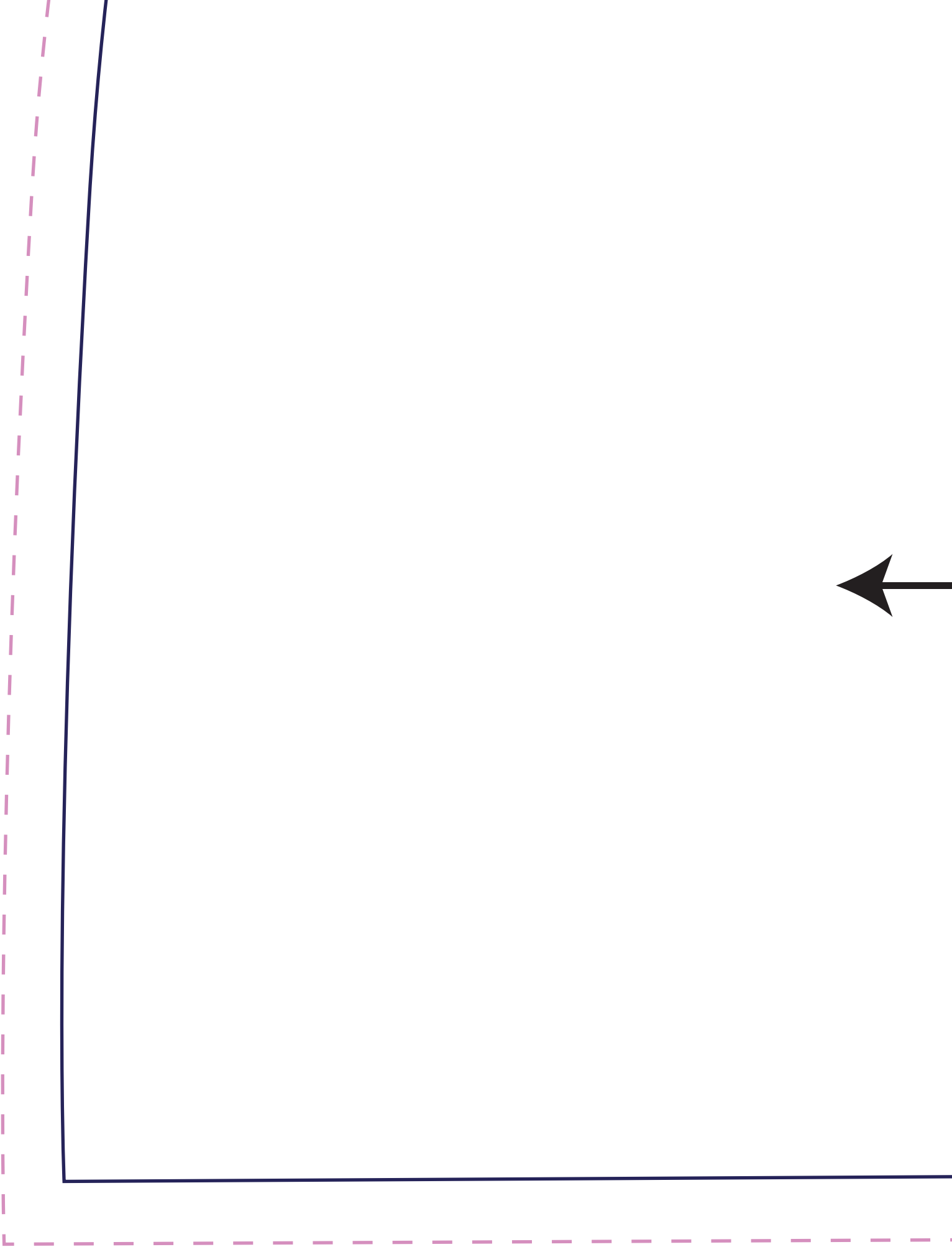

imp rano

[back]

cut x 2

---

---

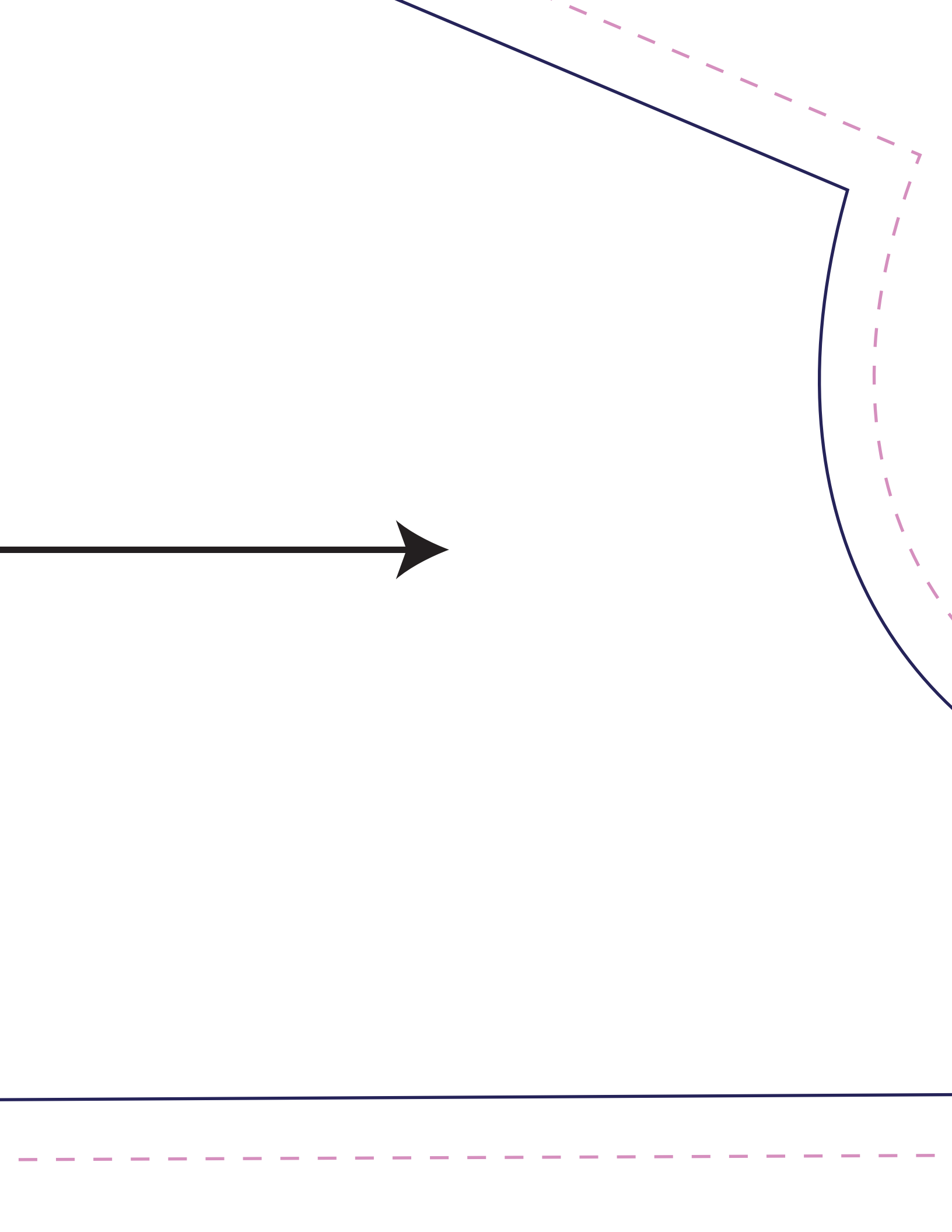



## **INSTRUCTIONS**

Cut pieces from fabric on pink line (dotted)

Sew back seam

Sew side seams

Sew shoulder seams

Turnover neckline, armholes and hem and sew



